

ACVATIX™

Electromotoric actuators for stroke valves

SAS..



Electromotoric actuators with 5.5 mm stroke and 400 N positioning force

- SAS31.. Operating voltage AC 230 V, 3-position control signal
- SAS61.. Operating voltage AC 24 V / DC 24 V, control signal DC 0...10 V / DC 4...20 mA / 0...1000 Ω
- SAS81.. Operating voltage AC/DC 24 V, 3-position control signal
- For direct mounting on valves; no adjustments required
- Manual adjuster, position indicator and status indication per LED
- Optional functions with auxiliary switch

For the operation of Siemens 2-port and 3-port valves:

- Types V..G44.. and VVG55..
- 5.5 mm stroke

As control or shutoff valves in heating and ventilation systems.

Functions

Function	Description	Type
3-position control	A 3-position signal drives the actuator via connection terminals Y1 or Y2. The required position is transferred to the valve.	SAS31.. SAS81..
Modulating control	The modulating positioning signal drives the actuator steplessly. The positioning signal range (DC 0...10 V / DC 4...20 mA / 0...1000 Ω) corresponds in a linear manner to the positioning range (fully closed...fully open, or 0...100 % stroke).	SAS61..
Positioning signal and flow characteristic selection	Setting the DIL switches. Factory setting: All DIL switches set to "OFF".	
Position feedback U	Signal used to acquire the position, fed back via an input.	
Calibration	During commissioning, the actuator detects the valve's end positions and files the exact stroke in its internal memory.	
Detection of valve seat	The actuators feature force-dependent valve seat detection. After calibration, the exact valve stroke is filed in the actuator's memory.	
Detection of foreign bodies	After detection of clogging, 3 attempts are made to overcome clogging. If the attempts made are unsuccessful, the actuator continues to follow the positioning signal within the restricted range only (LED continues to blink red).	
Forced control Z (Z mode)	Forced control serves for overriding automatic mode and is implemented in the structure.	

Type summary

Product no.	Stock no.	Operating voltage	Positioning signal	Power consumption	Posit. time	Fail safe funct./ Spr. return time	Manual adjuster	Position feedback	Remark
SAS31.00	S55158-A106	AC 230 V	3-position	2.8 / 2.4 VA ⁵⁾	120 s	No	Yes	-	1) 3)
SAS31.03	S55158-A107			3.5 / 2.9 VA ⁵⁾	30 s				
SAS31.50	S55158-A108			3.5 / 2.9 VA ⁵⁾	120 s	Yes / <28 s ⁶⁾	No		
SAS31.53	S55158-A109			5.5 / 3.8 VA ⁵⁾	30 s	Yes / <14 s ⁶⁾			
SAS61.03	S55158-A100-A100	AC/DC 24 V	DC 0...10 V DC 4...20 mA 0...1000 Ω	5.3 / 4.5 VA ⁵⁾	30 s	No	Yes	DC 0...10 V	1)
SAS61.03U	S55158-A106			5.3 / 4.5 VA ⁵⁾					2)
SAS61.33	S55158-A101			5.9 / 4.8 VA ⁵⁾		1)			
SAS61.33U	S55158-A101-A100			5.9 / 4.8 VA ⁵⁾	2)				
SAS61.53	S55158-A102			5.8 / 5.0 VA ⁵⁾	1)				
SAS61.33U	S55158-A101-A100			5.9 / 4.8 VA ⁵⁾	2)				
SAS81.00	S55158-A103	AC/DC 24 V	3-position	2.2 / 2.0 VA ⁵⁾	120 s	No	Yes	-	1) 4)
SAS81.00U	S55158-A103-A100			2.2 / 2.0 VA ⁵⁾	2)				
SAS81.03	S55158-A104			2.5 / 2.1 VA ⁵⁾	1)				
SAS81.03U	S55158-A104-A100			2.5 / 2.1 VA ⁵⁾	2)				
SAS81.33	S55158-A105			3.4 / 2.4 VA ⁵⁾	1)				
SAS81.33U	S55158-A105-A100			3.4 / 2.4 VA ⁵⁾	2)				
SAS81.33U	S55158-A105-A100			3.4 / 2.4 VA ⁵⁾	2)				

¹⁾ Cable gland: M16 and M20 (ISO50262)

²⁾ Cable gland: ½" (UL514C)

³⁾ Approbation: CE

⁴⁾ Approbation: CE and UL (only 24 V)

⁵⁾ Second value: Power consumption in neutral position

⁶⁾ Spring return time increased slightly at low temperatures

Accessories

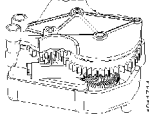
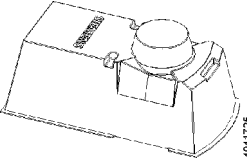
Electrical Accessory	Mechanical Accessory
Auxiliary switch ASC10.51	Weather shield ASK39.2
	

Ordering (Example)

Product no.	Stock no.	Description	Quantity
SAS31.00	S55158-A106	Actuator	1
+ auxiliary components (connections, auxiliary switches...)			

Delivery

Actuator, valve and accessories are supplied in individual packs.

Spare parts

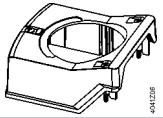
Stock number	Description
8000069479	Housing cover with screws and light conductor as an assembly, without laser marking
	

Equipment combinations

Valves PN16					Actuators SAS..	
VVG44.. (2-port)	VXG44.. (3-port)	DN	G	k_{vs}	Δp_s	Δp_{max}
Medium: 1...120 °C			[Inch]	[m ³ /h]	[kPa]	[kPa]
VVG44.15-..	VXG44.15-..	15	G 1 B	0.25 / 0.4 / 0.63	1600	400
VVG44.15-..	VXG44.15-..	15	G 1 B	1 / 1.6	725	400
VVG44.15-..	VXG44.15-..	15	G 1 B	2.5 / 4	400	400
VVG44.20-6.3	VXG44.20-6.3	20	G 1 ¼ B	6.3	750	400
VVG44.25-10	VXG44.25-10	25	G 1 ½ B	10	400	400
VVG44.32-16	VXG44.32-16	32	G 2 B	16	250	250
VVG44.40-25	VXG44.40-25	40	G 2 ¼ B	25	125	125

Valves PN 25					Actuators SAS..	
VVG55.. (2-port)		DN	G	k_{vs}	Δp_s	Δp_{max}
Medium: 1...130 °C			[Inch]	[m ³ /h]	[kPa]	[kPa]
VVG55.15-..		15	G ¾ B	0.25 / 0.4 / 0.63	2500	1200
VVG55.15-..		15	G ¾ B	1 / 1.6 / 2.5	2000	1200
VVG55.20-4		20	G 1 B	4	1000	1000
VVG44.25-6.3		25	G 1 ¼ B	6.3	800	800

¹⁾ With ALG..B fittings up to 100 °C

²⁾ Pressure compensated

Title	Topic	Document ID
Actuators SAS.., SAT.. for valves Basic Documentation	Detailed information about the SAS.. actuators	CE1P4041en

Related documents such as environmental declarations, CE declarations, etc., can be downloaded at the following Internet address:

<http://siemens.com/bt/download>

Notes

Safety

	<p>⚠ Caution</p>
	<p>National safety regulations</p> <p>Failure to comply with national safety regulations may result in personal injury and property damage.</p> <ul style="list-style-type: none"> • Observe national provisions and comply with the appropriate safety regulations.

Engineering

SAS31.., SAS81..

3-position actuators must have one specific controller each; refer to „Connection diagrams“.

SAS61..

Up to 10 actuators can drive in parallel on a controller output with a rating of 1 mA. Modulating actuators have an input impedance of 100 kΩ.

Mounting

Mounting positions

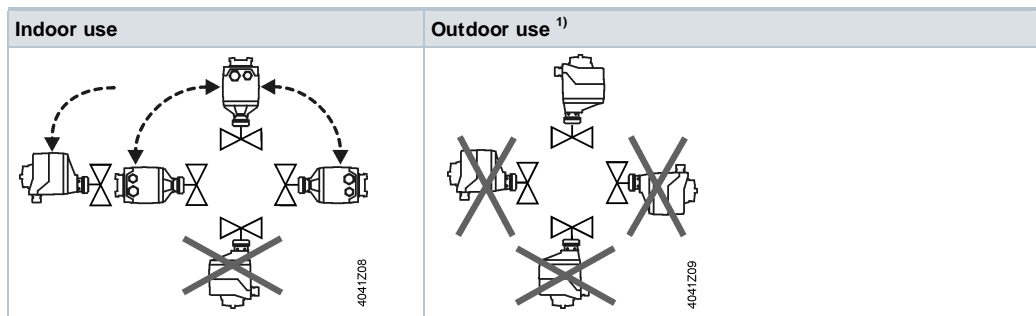

¹⁾ Only in connection with weather shield ASK39.2, housing protection IP54 remains unchanged

Maintenance

The actuators are maintenance-free.

Mounting:

- Do not touch the valve coupling if the components (valve/pipes) are hot
- If necessary, disconnect electrical connections from the terminals

The actuator must be correctly fitted to the valve before recommissioning.

Disposal



The device is considered an electronics device for disposal in terms of European Directive 2012/19/EU and may not be disposed of as domestic garbage.

- Dispose of the device through channels provided for this purpose.
- Comply with all local and currently applicable laws and regulations.

Warranty

Technical data on specific applications are valid only together with Siemens products listed under "Equipment combinations". Siemens rejects any and all warranties in the event that third-party products are used.

Note

When using the actuators in connection with valves of other manufacture, correct functioning must be ensured by the user, and Siemens will assume no responsibility.

Technical data

Power supply		SAS..
Operating voltage	SAS31..	AC 230 V \pm 15 %
	SAS61..	AC 24 V \pm 20 % / DC 24 V +20 % / -15 % or AC 24 V class 2 (US)
	SAS81..	AC/DC 24 V \pm 20 % or AC 24 V class 2 (US)
Frequency		45...65 Hz
External supply line protection (EU)		6 A...10 A slow or Circuit breaker max. 13 A Characteristic B, C, D according to EN 60898 Power source with current limitation of max. 10 A
Power consumption	at 50 Hz	Stem retracts / extends - see "Type summary"
Function data		
Positioning time with the specified nominal stroke	SAS..0	120 s
	SAS..3 / SAS..3U	30 s
Positioning force		400 N
Nominal stroke		5.5 mm
Permissible medium temperature	valve fitted	1...130 °C
Signal inputs		
Y positioning signal	SAS31../SAS81..	3-position
	SAS61..	DC 0...10 V / DC 4...20 mA / 0...1000 Ω
	SAS61.. (DC 0...10 V) Current draw	\leq 0.1 mA
	Input impedance	\geq 100 k Ω
	SAS61.. (DC 4...20 mA) Current draw	DC 4...20 mA \pm 1 %
	Input impedance	\leq 500 Ω
Parallel operation		
	SAS61..	\leq 10 (depending on controller output)

Forced control		
Positioning signal Z	SAS61..	R = 0...1000 Ω, G, G0
	R = 0...1000 Ω	stroke proportional to R
	Z connected to G	max. stroke 100 %
	Z connected to G0	min. stroke 0 %
	Voltage	max. AC 24 V +20 % / max. DC 24 V +20 % / -15 %
	Current draw	≤ 0.1 mA
Position feedback		
U	SAS61..	DC 0...10 V ± 1 %
	Load impedance	> 10 kΩ res.
	Load	max. 1 mA
Connecting cable		
Wire cross-sectional areas		0.75...1.5 mm ² , AWG 20...16 ¹⁾
Cable entries	SAS.. (EU)	1 entry Ø 16.4 mm (for M16) 1 entry Ø 20.5 mm (for M20)
	SAS..U (US)	2 entries Ø 21.5 mm for ½" tube connection
Degree of protection		
Housing protection	(Mounting position)	IP 54 as per EN 60529 ²⁾ (vertical)
Insulation class		As per EN 60730
	Actuators SAS31.. AC 230 V	II
	Actuators SAS61.. AC / DC 24 V	III
	Actuators SAS81.. AC / DC 24 V	III
Environmental conditions		
Operation		IEC 60721-3-3
	Climatic conditions	Class 3K5
	Mounting location	Indoors, outdoors ³⁾
	Temperature general	-5...55 °C
	Humidity (noncondensing)	5...95 % r. F.
Transport		IEC 60721-3-2
	Climatic conditions	Class 2K3
	Temperature	-25...70 °C
Storage		IEC 60721-3-1
	Temperature	-15...55 °C
	Humidity	5...95 % r. F.
Directives and Standards		
Product standard		EN60730-x
Electromagnetic compatibility (Application)		For residential, commercial and industrial environments
EU Conformity (CE)		CE1T4581xx ⁴⁾
RCM Conformity		CE1T4581en_C1 ⁴⁾
UL, cUL	AC / DC 24 V	UL 873 http://ul.com/database

Environmental compatibility		
		The product environmental declaration CE1E4581 contains data on environmentally compatible product design and assessments (RoHS compliance, materials composition, packaging, environmental benefit, disposal).
Dimensions / Weight		
		See "Dimensions"
Accessories ⁵⁾		
Auxiliary switch ASC10.51	Switching capacity	AC 24...230 V, 6 (2) A, floating
	External supply line protection	See section power supply
	US installation, UL & cUL	AC 24 V class 2, 5 A general purpose

- ¹⁾ AWG = American wire gauge.
Wire cross-sectional areas and fuses have to be well-matching, which is the responsibility of the planner / installer. Observe norm of protection measures - protection against overcurrent:
IEC 60364-4-43:2008 resp. german adoption HD 60364-4-43:2010.
- ²⁾ Also with weather shield ASK39.2
- ³⁾ Outdoors always with weather shield ASK39.2, housing protection IP54 remains unchanged
- ⁴⁾ The documents can be downloaded from <http://siemens.com/bt/download>
- ⁵⁾ UL recognized component

Internal Diagrams

SAS31..

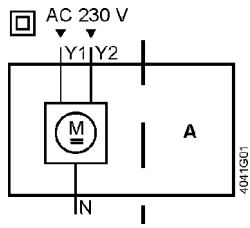

SAS31.5..

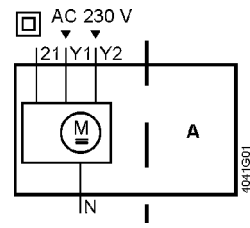

SAS61..

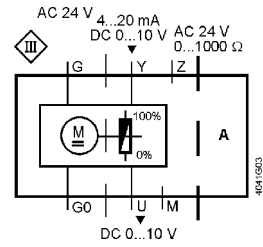

SAS81..

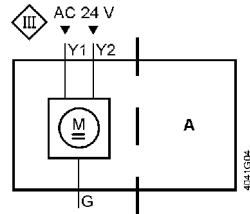

SAS81.33, SAS81.33U

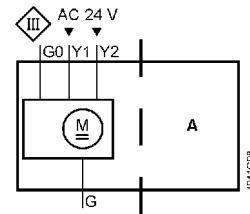

Accessory plug-in space A
1x ASC10.51

ASC10.51

AC 24 V...230 V / 6 (3) A

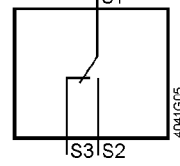

Connection terminals

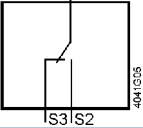
SAS31..		AC 230 V, 3-position
40-10217	N	System neutral (SN)
	Y1	Positioning signal (actuator's stem extends / actuator's spindle turns cw ¹⁾)
	Y2	Positioning signal (actuator's stem retracts / actuator's spindle turns ccw ²⁾)
SAS31.5..		AC 230 V, 3-position
40-1732	N	System neutral (SN)
	Y1	Positioning signal (actuator's stem extends / actuator's spindle turns cw ¹⁾)
	Y2	Positioning signal (actuator's stem retracts / actuator's spindle turns ccw ²⁾)
	Z1	Fail safe function
SAS61..		AC/DC 24 V, DC 0...10 V / 4...20 mA / 0...1000 Ω
40-0216	G0	System neutral (SN)
	G	System potential (SP)
	Y	Positioning signal for DC 0...10 V / 4...20 mA
	M	Measuring neutral
	U	Position feedback DC 0...10 V
	Z	Positioning signal forced control AC/DC ≤ 24 V, 0...1000 Ω
SAS81..		AC/DC 24 V, 3-position
40-0218	G	System potential (SP)
	Y1	Positioning signal (actuator's stem extends / actuator's spindle turns cw ¹⁾)
	Y2	Positioning signal (actuator's stem retracts / actuator's spindle turns ccw ²⁾)
SAS81.33U		AC/DC 24 V, 3-position
40-1730	G	System potential (SP)
	Y1	Positioning signal (actuator's stem extends / actuator's spindle turns cw ¹⁾)
	Y2	Positioning signal (actuator's stem retracts / actuator's spindle turns ccw ²⁾)
	G0	System neutral (SN)
Electrical accessories		
ASC10.51	Auxiliary switch. Adjustable switching points, AC 24...230 V	
40-10217	1	System potential (SP)
	2	Closing (actuator's stem extends / actuator's spindle turns cw ¹⁾)
	3	Opening (actuator's stem extends / actuator's spindle turns cw ¹⁾)
		<p>AC 24 V...230 V / 6 (3) A</p>  <p>40-10217</p>
	<p>¹⁾ cw = clockwise</p> <p>²⁾ ccw = counter-clockwise</p>	

Connection diagrams

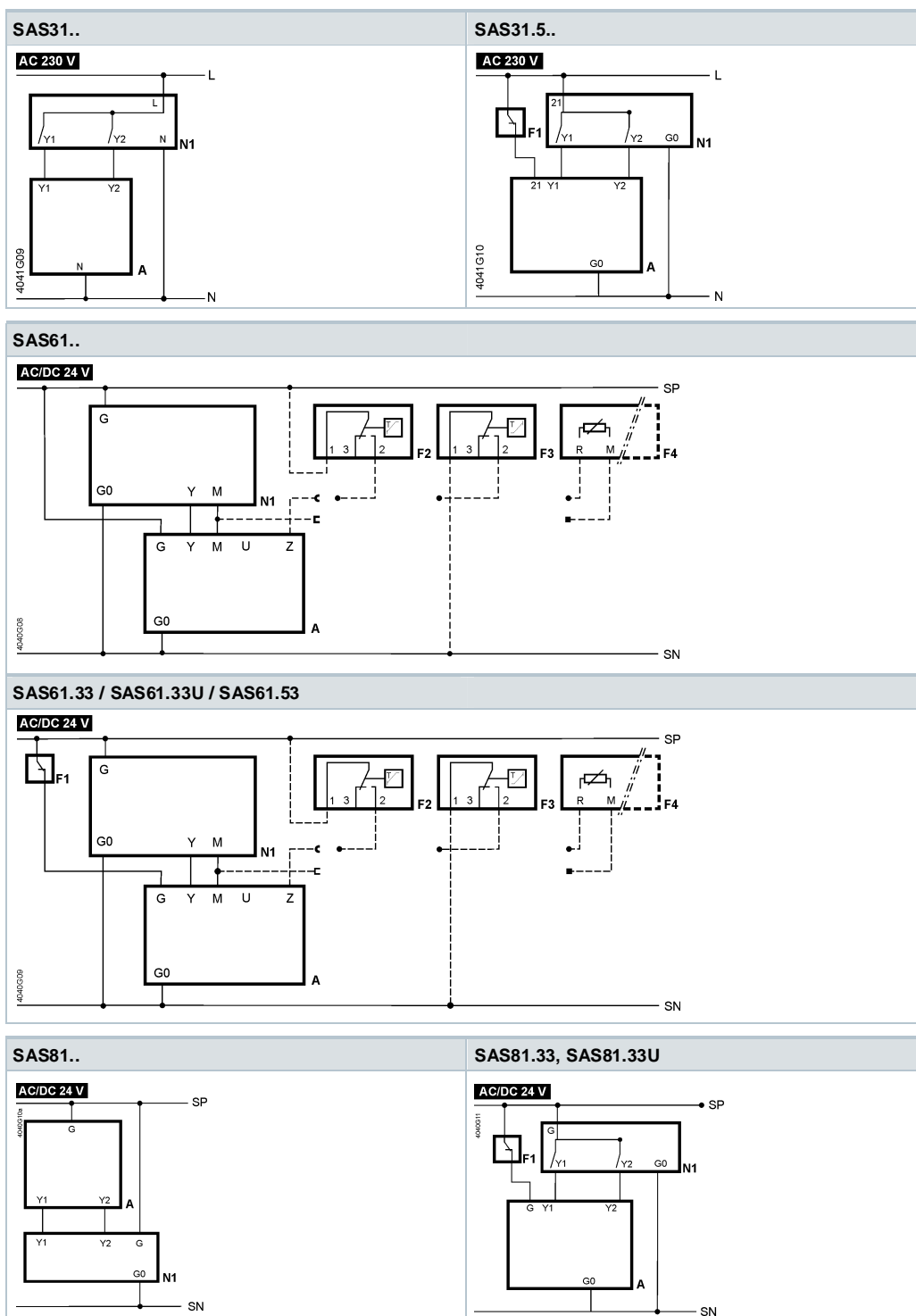

- | | |
|---|--|
| <p>A Actuator</p> <p>F1 Temperature limiter</p> <p>F2 Frost protection thermostat; terminals:
1 – 2 frost hazard / sensor is interrupted
(thermostat closes with frost)
1 – 3 normal operation</p> <p>F3 Temperature detector</p> <p>F4 Frost protection monitor with 0...1000 Ω signal
output, does NOT support QAF21.. or QAF61..</p> <p>L Phase</p> | <p>M Measuring neutral</p> <p>N Neutral</p> <p>N1 Controller</p> <p>SN System neutral</p> <p>SP System potential AC/DC 24 V</p> <p>U Position feedback</p> <p>Y Positioning signal</p> <p>Y1, Y2 Positioning signals</p> <p>Z Positioning signal forced control</p> <p>21 Fail safe function</p> |
|---|--|

Actuators SAS.. with manual adjuster

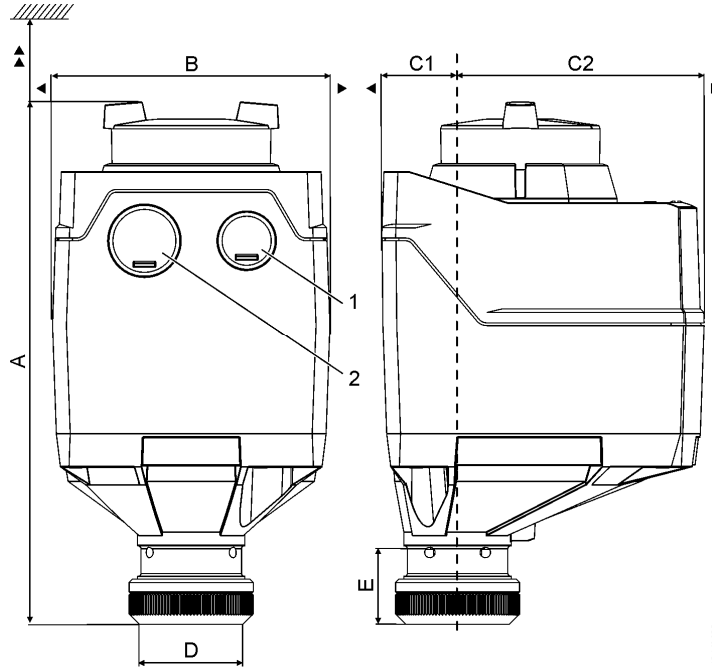

Product no.	A [mm]	B [mm]	C [mm]	C1 [mm]	C2 [mm]	D [mm]	E [mm]	▶ [mm]	▶▶ [mm]	kg [kg]	1	2
SAS..	151	80	93	21,9	71.1	29,9	21,8	100	200	0.4	M16 ¹⁾	M20 ¹⁾
With ASK39.2	155	126	248	99	149	29,9	21,8	100	200	0.5	M16 ¹⁾	M20 ¹⁾

¹⁾ SAS..U: ½" (Ø 21,5 mm)

Actuators SAS.. without manual adjuster

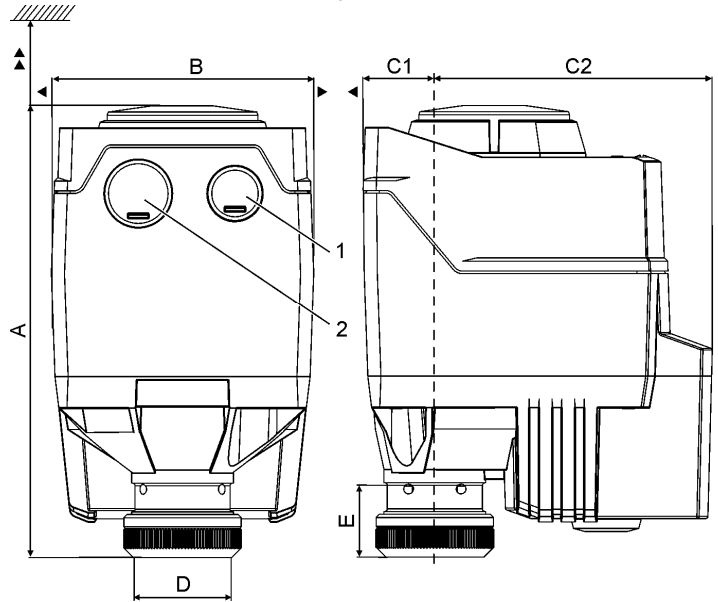

Product no.	A [mm]	B [mm]	C [mm]	C1 [mm]	C2 [mm]	D [mm]	E [mm]	▶ [mm]	▶▶ [mm]	kg [kg]	1	2
SAS..	137.6 ¹⁾ 151 ²⁾	80	106.5	21.9	84.6	29,9	21,8	100	200	0.68	M16	M20
With ASK39.2	155	126	248	99	149	29,9	21,8	100	200	0.83	M16	M20

¹⁾ Black cover

²⁾ Blue manual adjuster

Revision numbers

Product no.	Valid from rev. no.
SAS31.00	..A
SAS31.03	..A
SAS31.50	..A
SAS31.53	..A
SAS61.03	..A
SAS61.03U	..A
SAS61.33	..A
SAS61.33U	..A
SAS61.53	..A
SAS81.00	..A
SAS81.00U	..A
SAS81.03	..A
SAS81.03U	..A
SAS81.33	..A
SAS81.33U	..A

Unrestricted Issued by
Siemens Switzerland Ltd
Building Technologies Division
International Headquarters
Gubelstrasse 22
6301 Zug
Switzerland
Tel. +41 41-724 24 24
www.siemens.com/buildingtechnologies

© Siemens Switzerland Ltd, 2015
Technical specifications and availability subject to change without notice.

Document ID CE1N4581en
Issue 2015-05-19